

Capitol

PROJECT NAME / NOM DU PROJET



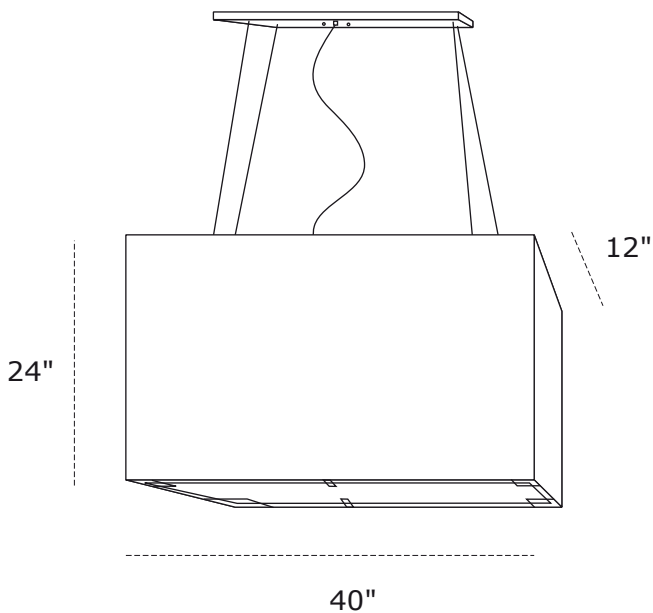
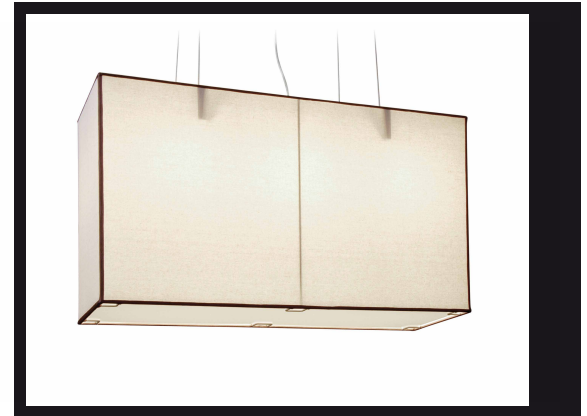

Date

Type

Notes

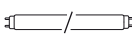

Light source / Source lumineuse

3 x BULB A19 Med	75W		<input type="checkbox"/>
3 x BULB Fluo Comp	23W		<input type="checkbox"/>
2 x T5	39W		<input type="checkbox"/>
2 x T8	25W		<input type="checkbox"/>
3 x BULB GU24 Base	26W		<input type="checkbox"/>
LED			<input type="checkbox"/>

** Other light source / wattage available on request*

Voltage / Voltage

120V 277V 347V

** Dimmable ballast available*

Structure finish / Fini structure

Satin nickel	<input type="checkbox"/>	Brushed brass	<input type="checkbox"/>
Chrome	<input type="checkbox"/>	White	<input type="checkbox"/>
Brass	<input type="checkbox"/>	Black	<input type="checkbox"/>

** Other finishes available on request*

Suspension option / Option de suspension

Satin nickel stem	<input type="checkbox"/>	White stem	<input type="checkbox"/>
Chrome stem	<input type="checkbox"/>	Brass stem	<input type="checkbox"/>
Black stem	<input type="checkbox"/>	Satin brass stem	<input type="checkbox"/>
Aircraft cable + clear cable	<input type="checkbox"/>		
Aircraft cable + black cable	<input type="checkbox"/>		
Aircraft cable + white cable	<input type="checkbox"/>		

** Other finishes available*

*** Sloped ceiling adapter available*

Shade finish / Fini d'abat-jour

White fabric	<input type="checkbox"/>	Beige fabric	<input type="checkbox"/>
Black fabric	<input type="checkbox"/>	Polycarbonate	<input type="checkbox"/>
Ivory fabric	<input type="checkbox"/>	Acrylic	<input type="checkbox"/>

** Other colors and textures available*

Diffuseur / Diffuseur

White acrylic	<input type="checkbox"/>	Red acrylic	<input type="checkbox"/>
---------------	--------------------------	-------------	--------------------------

** Other colors available*

All standard and custom-made product were tested and approved according to the code of normalizations (standardizations). A label affixed on the product gives evidence of it.

Tous produits standards et sur mesure ont été testés et approuvés selon le code de normalisations. Une étiquette apposée sur le produit en atteste.